

Reticle instructions for Lynx LX2 3.5-10x50 RF

TO USE THE RANGE-FINDING SCALE FOR TARGET ANIMALS LARGER THAN 1 METRE

Set the scope magnification according to target animal size using the table below, range the target animal by fitting him, hoof to withers, between the scale baseline and the range lines.

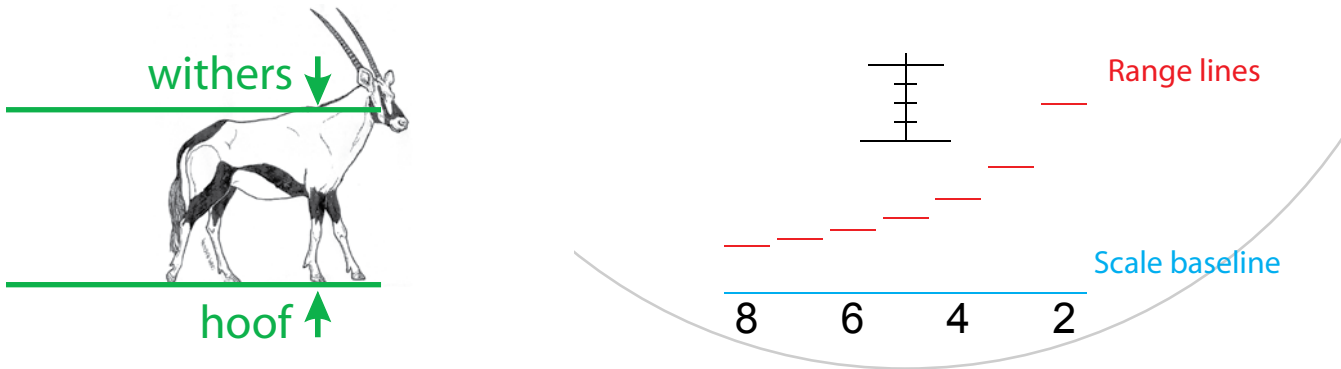

The withers is the ridge between the shoulder-blades of a four-legged animal. In many species it is the tallest point of the body.

	Shoulder height	Magnification
Nyala	1120 mm	8.9 (9x)
Waterbuck / Gemsbok / Oryx	1200 mm	8.3 (8.5x)
Sable	1350 mm	7.4 (7.5x)
Kudu	1400 mm	7.1 (7x)
Blue Wildebeest	1500 mm	6.7 (7x)
Eland	1700 mm	5.9 (6x)

Table 1

Read off the target distance on the even numbers below the scale, 2 = 200 metres, 4 = 400 metres etc. Intermediate lines (shown in blue below) representing 300, 500 & 700 metres have no number printed below the scale.

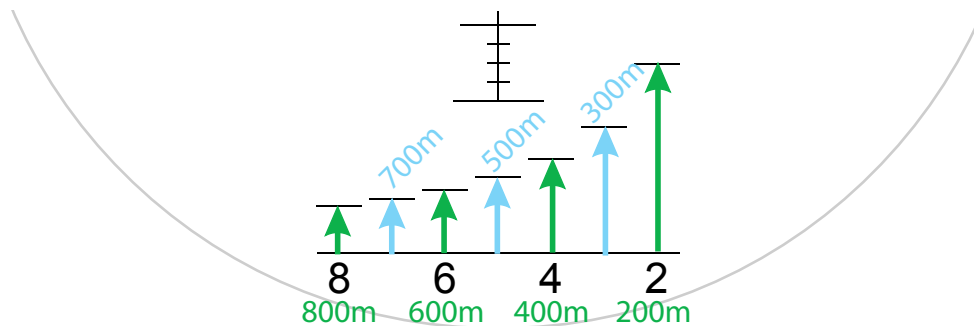

Ranging scale distances for target animals larger than 1 metre at the shoulder

In the example below the scope magnification is set to 8.5x (refer to the magnification column in table 1 above) to range an oryx-sized target. The oryx pictured here is standing 400 metres away as indicated by the number '4' on the range-finding baseline.

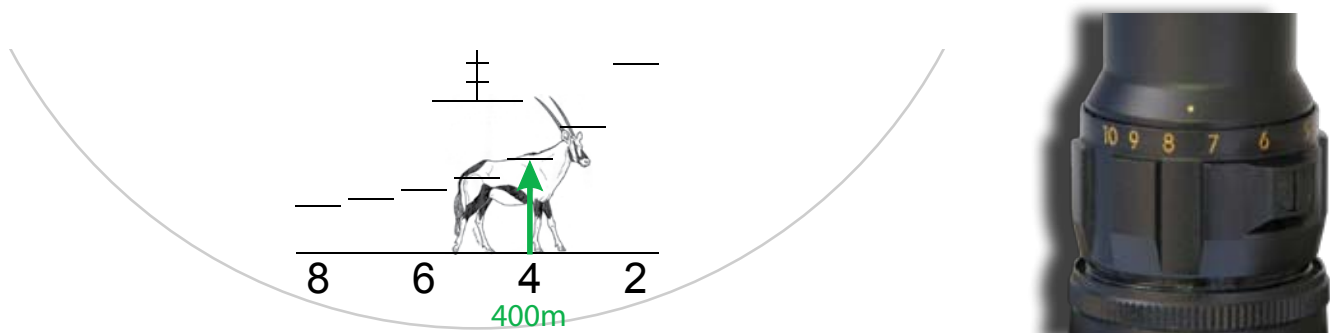

To USE THE RANGE-FINDING SCALE FOR TARGET ANIMALS 0.5 METRE TO 1 METRE

Set the scope magnification according to target animal size using the table below, range the target animal by fitting him, hoof to withers, between the scale baseline and one of the range lines.

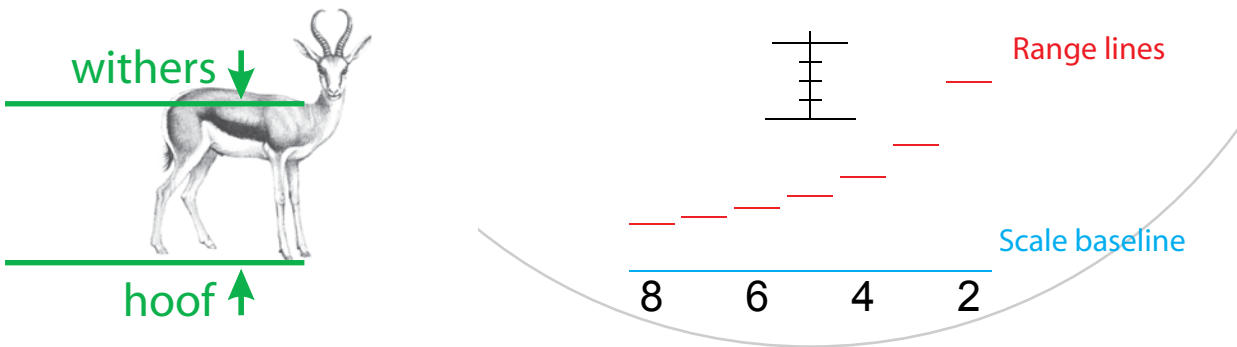

	Shoulder height	Magnification
Warthog	650 mm	7.7 (8x)
Springbok	750 mm	6.7 (7x)
Bosbok	800 mm	6.3 (6.5x)
Rooibok / Impala	900 mm	5.6 (5.5x)
Blesbok	950 mm	5.3 (5.5x)

Table 2

Read off the number **and halve it** for target distance, i.e., 2 = 100 metres, 4 = 200 metres, 6 = 300 and 8 = 400 metres. Intermediate lines representing 150, 250 and 350 metres have no number printed below the scale.

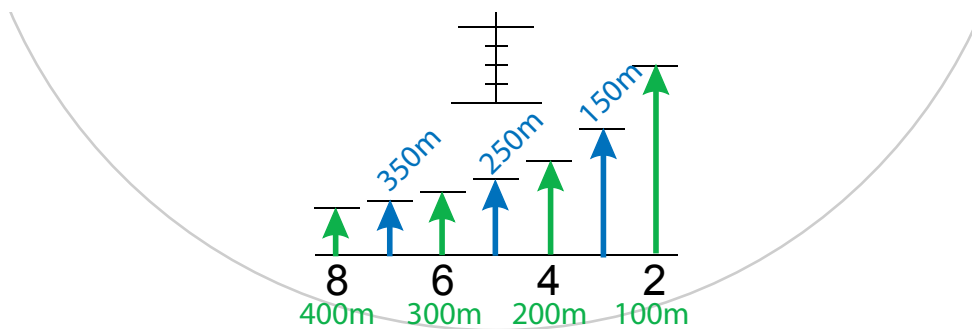

Ranging scale distances for target animals 0.5 to 1 metre at the shoulder

NB: Remember when using the scale for animals smaller than 1 metre the distance reading on the scale must be halved to determine the correct range to target.

In the example below the scope magnification is set to 6.5x (refer to the magnification column in table 2 above) to range a springbok-sized target. The springbok pictured here is standing 200 metres away as indicated by the number '4' on the range-finding baseline.

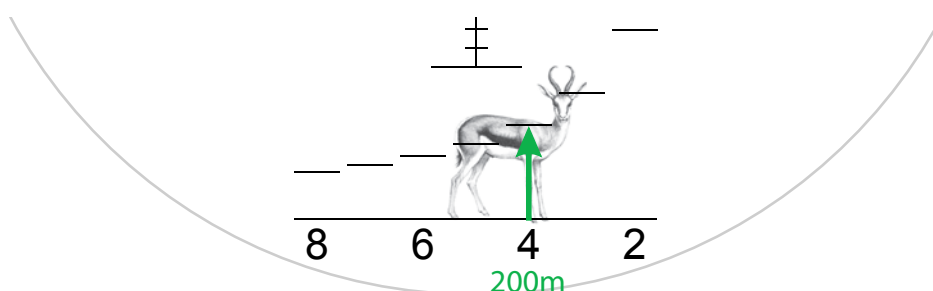

USING THE CENTRE POST SCALE TO DETERMINE TARGET DISTANCE

More versatile than the ranging scale, the centre post scale is graduated in US Military mils and can be used to range target animals of any size without having to change scope magnification from 10x.

With the scope set at 10x each small graduation line on the scale represents 0.5 mil and each large graduation line represents 2 mils. The diagram below shows that the centre scale is 12 mils high from the range-finding scale baseline, 10 mils high from the centre range line on the ranging scale and 8 mils if the 0.5 mil graduated scale is used.

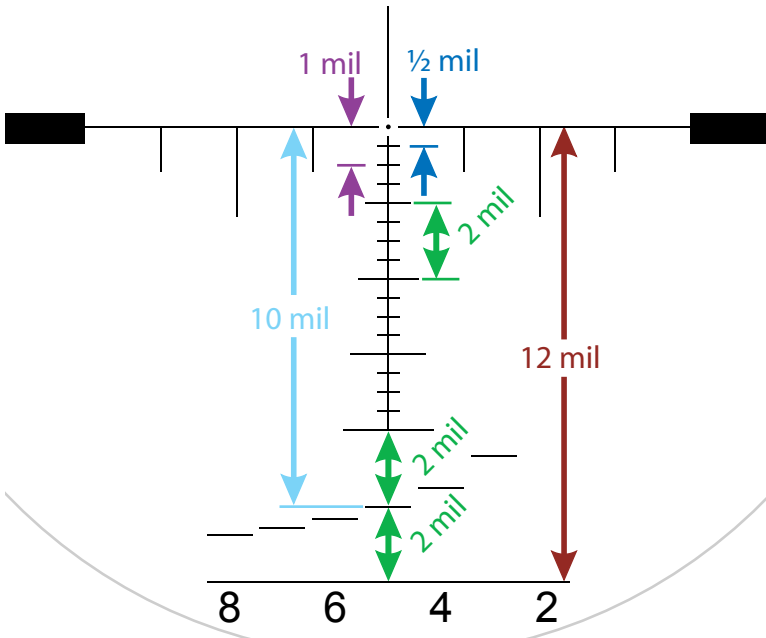

Set the scope to 10x and hold the centre scale over the target animal, hoof to withers. Divide the animal height in millimetres by the number of mils it covers and you have the distance to target in metres.

In the example below the scope magnification is set to 10x to use the centre post scale. The springbok pictured here is standing 250 metres away (750mm divided by 3).

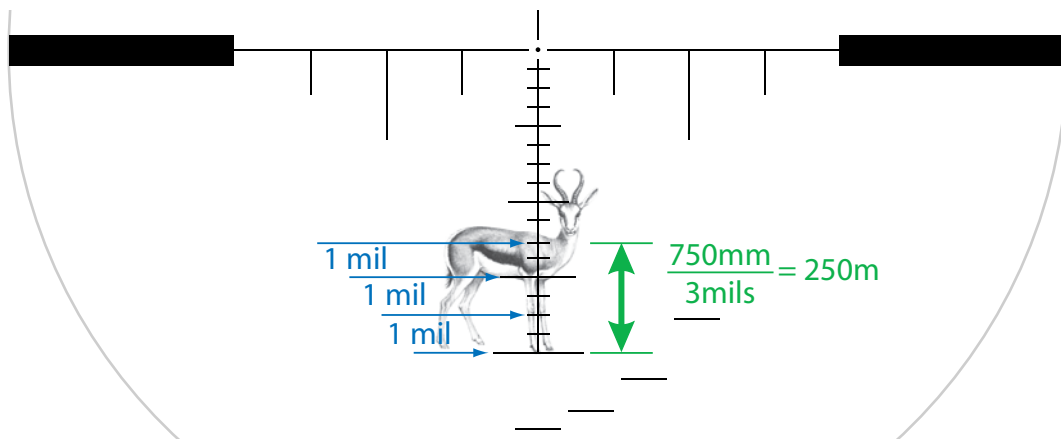

Using the reticle dimension table on the next page all centre post scale dimensions are given for magnifications from 3.5x to 10x. To calculate a given dimension for any other magnification setting use the "Reference @ 1x" column and divide it by the magnification you wish to use.

LX2 3.5-10x50(RF) instructions v1.1.08. Copyright Lynx Optics. Printed in South Africa.

Lynx Optics (Pty) Limited

PO Box 98078 Sloane Park South Africa 2152 • tel +27(0)11 792 6644 • fax +27(0)11 792 8923 • info@lynx.co.za • www.lynx.co.za

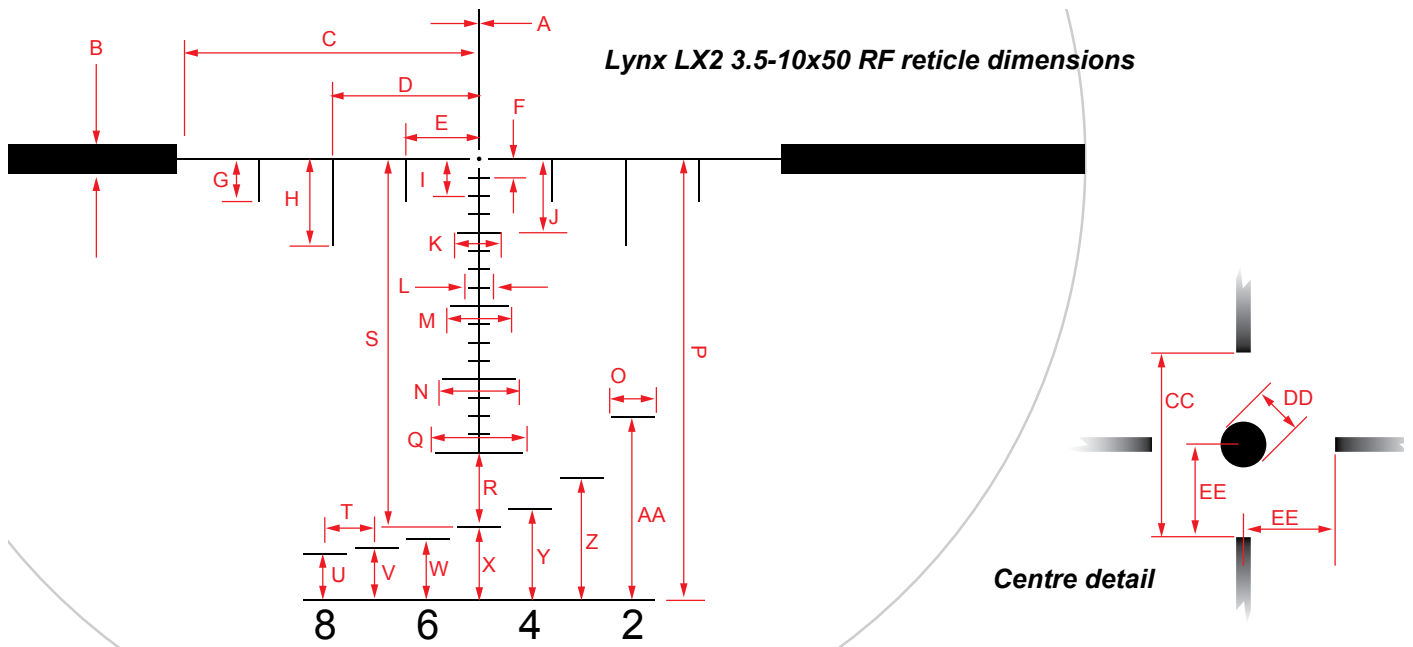

Reference	Reticle dimensions in millimetres @ 100 metres at various scope magnification									Mils @ 10x
	@ 1x	10x	9x	8x	7x	6x	5x	4x	3.5x	
A	30	3	3	4	4	5	6	8	9	
B	800	80	89	100	114	133	160	200	229	
C	8 000	800	889	1 000	1 143	1 333	1 600	2 000	2 286	
D	4 000	400	444	500	571	667	800	1 000	1 143	
E	2 000	200	222	250	286	333	400	500	571	
F	500	50	56	63	71	83	100	125	143	0.5 mil
G	1 200	120	133	150	171	200	240	300	343	
H	2 400	240	267	300	343	400	480	600	686	
I	1 000	100	111	125	143	167	200	250	286	1 mil
J	2 000	200	222	250	286	333	400	500	571	2 mil
K	1 200	120	133	150	171	200	240	300	343	
L	600	60	67	75	86	100	120	150	171	
M	1 600	160	178	200	229	267	320	400	457	
N	2 000	200	222	250	286	333	400	500	571	
O	1 200	120	133	150	171	200	240	300	343	
P	12 000	1 200	1 333	1 500	1 714	2 000	2 400	3 000	3 429	12 mil
Q	2 400	240	267	300	343	400	480	600	686	
R	2 000	200	222	250	286	333	400	500	571	2 mil
S	10 000	1 000	1 111	1 250	1 429	1 667	2 000	2 500	2 857	10 mil
T	1 200	120	133	150	171	200	240	300	343	
U	1 260	126	140	158	180	210	252	315	360	
V	1 420	142	158	178	203	237	284	355	406	
W	1 660	166	184	208	237	277	332	415	474	
X	2 000	200	222	250	286	333	400	500	571	
Y	2 500	250	278	313	357	417	500	625	714	
Z	3 340	334	371	418	477	557	668	835	954	
AA	5 000	500	556	625	714	833	1 000	1 250	1 429	5 mil
Reticle centre (millimetres @ 100 metres)										
CC	500	50	56	63	71	83	100	125	143	
DD	125	13	14	16	18	21	25	31	36	
EE	250	25	28	31	36	42	50	63	71	